

CHEMISTRY THAT MATTERS™



TRANSPARENT NOISE BARRIER SOLUTIONS

WITH LEXAN™ POLYCARBONATE SHEET



CONTENT

SABIC FUNCTIONAL FORMS	04
ABOUT LEXAN™ POLYCARBONATE SHEET	05
INTRODUCTION	06
WHAT ARE NOISE BARRIERS?	06
THE IMPORTANCE OF NOISE BARRIERS	06
NOISE BARRIERS STANDARDS	07
LEXAN™ SHEET FOR ACOUSTIC ELEMENTS	07
PRODUCT SOLUTIONS	08
LEXAN™ SHEET ACOUSTIC PERFORMANCE	08
LEXAN™ SHEET NON-ACOUSTIC PERFORMANCE	09
LEXAN™ SHEET BENEFICIAL FEATURES	10
PRODUCT COMPARISON	11
PRODUCT AVAILABILITY	11
PROJECT REFERENCES	12
CONCEPTS & INSTALLATION	15
RISK OF FALLING DEBRIS	15
DESIGN CONCEPTS	16
INSTALLATION GUIDELINES	18
LOCAL SERVICES & SUPPLY	19



SABIC FUNCTIONAL FORMS

SABIC's Functional Forms business offers high quality, engineered thermoplastic sheet and film products across a wide variety of industries, ranging from building and construction, consumer electronics, aircraft and rail-interiors to displays. Our LEXAN™ polycarbonate film & sheet portfolio is backed by advanced technical support and application development services around the world to meet our customers' global specification needs with local supply.

At SABIC, we are dedicated to meeting our customers' ever-changing needs with our unique high performance LEXAN film and sheet portfolio. Through our services and product portfolio, we help our customers to reduce system costs, create innovative designs with better functionality and develop environmentally responsible applications.

ABOUT LEXAN™ POLYCARBONATE SHEET

SABIC's LEXAN™ polycarbonate sheet products are directly extruded from LEXAN™ resin, which is a polycarbonate material, and offer significant advantages over many other glazing materials in terms of design freedom, light-weight, fire performance, UV protection and thermal insulation. LEXAN™ polycarbonate sheet combines high impact resistance with optical clarity, thus providing superior safety and security against vandalism and intrusion.

In sound wall and noise barrier applications, LEXAN polycarbonate sheet provides opportunities for highly effective, unobtrusive sound screens with large glazing panels. Our products provide high impact resistance over a wide temperature range, helping to minimize the risk of damage by accidents or vandalism. Due to its long-term UV

protection on both sides, also LEXAN sheet is highly resistant to yellowing and loss of performance due to weathering and virtually doesn't contribute to the spread of fire and the generation of toxic gases. Also it is easy to transport and install on-site with conventional metal working tools.

Renewing the façade of Aviva Stadium , Dublin, Ireland
with transparent and acoustic LEXAN™ EXELL™ D Sheet



INTRODUCTION

WHAT ARE NOISE BARRIERS?

A noise barrier (sound wall, sound barrier, or acoustical barrier) is designed to protect inhabitants from noise pollution by reducing outdoor noise pollution, for instance the noise of road or rail traffic. A noise barrier includes structural elements and acoustic elements, see Image 1.

Generally, noise barriers have two acoustic specifications called sound insulation and sound absorption. Sound absorbing materials are the materials that will absorb and convert some or all of the sound into heat. While, sound insulation means preventing sound from transferring one side to another by reflecting the sound.

SABIC's Functional Forms offers LEXAN™ polycarbonate sheet for acoustic elements with high performance in sound insulation.

THE IMPORTANCE OF NOISE BARRIERS

The maximum suitable level of sound for human is 60 dB, which equals a normal conversation between two people standing at a distance of one meter. The pleasure environment's sound level can be around 30 dB. The sound level higher than 70 dB over a constant period of time can cause a stressful situation or annoyance, for example a washing machine or a dishwasher sound. Moreover, the noise above 85 dB can in a short time (for example, 5 minutes to 2 hours) or immediately damage human ears. For instance, on average, a motorcycle can have 95 dB of loudness, or a train horn has 100 dB of loudness.

Moreover, in the context of contemporary urban development, aesthetic design constitutes an essential criterion. The utilization of transparent LEXAN sheets present a unique opportunity to incorporate a modern design aesthetic. These thinner sheets (in comparison to traditional materials) enable an unobstructed view for drivers while simultaneously enhancing the overall appearance.

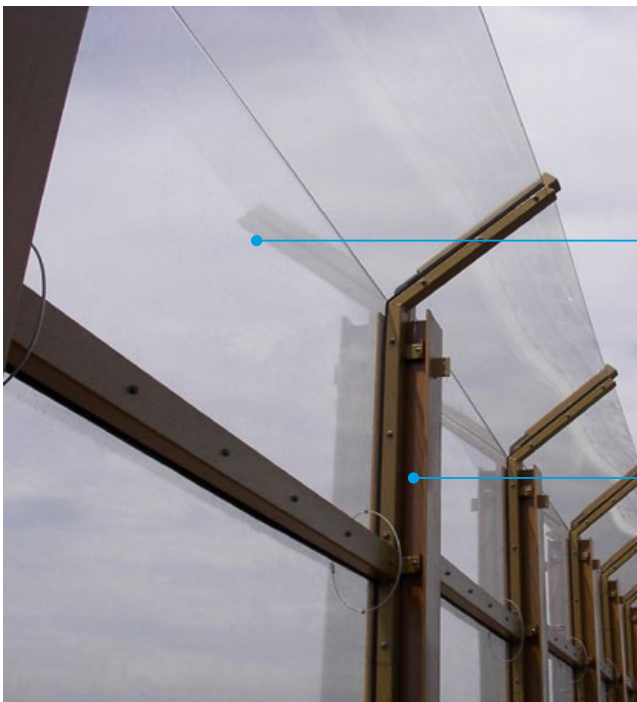

ACOUSTIC ELEMENT

STRUCTURAL ELEMENT

Image 1: Noise Barrier Elements



Noise Barriers, ENOC Fuel station, Dubai, UAE – With LEXAN™ EXELL™ D Opal white sheet

NOISE BARRIERS STANDARDS

Most important required standards for performance measurement of Noise Barriers include (European standards):

ACOUSTIC PERFORMANCES

EN1793-1: A laboratory method for measuring the sound absorption performance.

EN1793-2: A laboratory method for measuring the airborne sound insulation performance.

EN1793-3: Gives a normalized traffic noise spectrum for the evaluation and assessment of the acoustic performance

ISO717-1: Defines single-number quantities for airborne sound insulation in buildings and of building elements

NON-ACOUSTIC PERFORMANCES

EN1794-1: Mechanical performance and stability requirements including: wind load and static load, self-weight, impact of stones, safety in collision, and dynamic load from snow clearance.

EN1794-2: General safety and environmental requirements including: risk of falling debris, environmental protection, means of escape in emergency, light reflection, and transparency.

EN1794-3: Reaction to fire - burning behaviour of noise reducing devices and classification.

LEXAN™ SHEET ACOUSTIC ELEMENTS

LEXAN™ EXELL™ D, LEXAN™ MARGARD™ and LEXAN™ EXTRITE™ sheet are transparent polycarbonate sheet materials, ideally suited for use in sound screens (as acoustic elements). Due to their unique properties these products are ideal for demanding sound screens and noise reduction barrier applications in urban, road, rail and airport environments. Proven in use throughout Europe, US and Pacific region, they carry our industry-leading ten year limited warranty against breakage.

In addition to the inherent characteristics of a polycarbonate material, LEXAN™ MARGARD™ comes with anti-graffiti and has a proprietary hard surface coating, on one or two sides, which provides a high level of resistance to abrasion and weathering.

The products are backed by a limited warranty against loss of light transmission, coating failure and breakage.

PRODUCT SOLUTIONS

SABIC FUNCTIONAL FORMS PRODUCT OFFERINGS FOR NOISE BARRIER APPLICATIONS

LEXAN™ EXELL™ D Sheet:

This virtually unbreakable, transparent, polycarbonate materials under LEXAN™ sheet portfolio come with UV protection on one or both sides and provide remarkable clarity - even after many years of intense sunlight and weather extremes.

LEXAN™ EXTRITE™ Sheet:

A transparent polycarbonate solid sheet with proprietary UV protection on both sides offering excellent weathering properties. With its excellent impact and abrasion resistance it is a perfect candidate for a wide variety of building and construction and other glazing applications.

To the new protective layer, the material is fulfilling a demand for areas where abrasion resistance and weathering is important. The intrinsic properties of LEXAN™ polycarbonate combined with a protective layer results in improved abrasion, chemical and UV resistance.

LEXAN™ MARGARD™ Sheet:

Lightweight, coated MARGARD™ Sheet products are highly resistant to abrasion, chemicals and have excellent weathering properties. LEXAN™ MARGARD™ Coated Sheet not only has the usual properties of a polycarbonate material, it also has a proprietary hard surface coating on one or both sides. This makes it highly resistant to abrasion and weathering. Available clear or tints, products come with a limited warranty against loss of light transmission, coating failure and breakage.

LEXAN™ SHEET ACOUSTIC PERFORMANCE

LEXAN™ sheet is tested according the current global standards for acoustic and non-acoustic elements. Test data demonstrates that LEXAN™ EXELL™ D, LEXAN™ MARGARD™ and LEXAN™ EXTRITE™ sheet match the acoustic performance of traditional materials, but with a significantly thinner LEXAN™ polycarbonate screen. The sound insulation test results is provided in Table 1:

Sheet thickness (mm)	Noise reduction (dB)	
	ISO 717-1 (R _w) ¹	EN 1793-2 (D _{L-R}) ²
8	32	28
9.5	33	29
12	34	30
15	35	32

¹ Noise Reduction Inside building

² Noise Reduction Specifically for traffic noise

Table 1: Noise Reduction Test Results



NON-ACOUSTIC PERFORMANCE



EXTREMELY HIGH IMPACT RESISTANCE

Virtually unbreakable and resistant to abrasion – 250 times stronger than glass, retaining exceptionally high impact resistance, minimizing the risk of damage by accidents or vandalism (Image 2).



EXCELLENT OPTICAL CLARITY

High transparency / up to 90%



UV PROTECTED FOR LONG-TERM DURABILITY

With superior UV protection on both sides, these sheets are highly resistant to yellowing and loss of performance due to weathering, as covered in the limited warranty conditions of all products.



MINIMIZING THE RISK OF FALLEN DEBRIS

Certified with EN 1794-2 standard in highest safety class (see page 15)

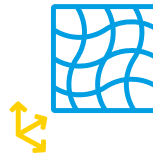

MAXIMUM NORMAL WIND LOAD AND STATIC (VERTICAL) LOAD



FIRE RESISTANCE

LEXAN™ sheet does not contribute to spread of flames, fire and generation of toxic gas. These PC sheets are certified to EN1794-3 in class 3, demonstrating their reaction to fire and burning behavior using brushwood fire test method (Image 3).



DYNAMIC LOAD FROM SNOW CLEARANCE

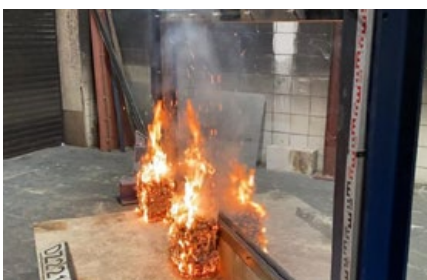

Image 3: Brushwood Fire Test Before - After test

Falling dart impact test 2.3 kg. steel dart 25.4 mm diameter tip

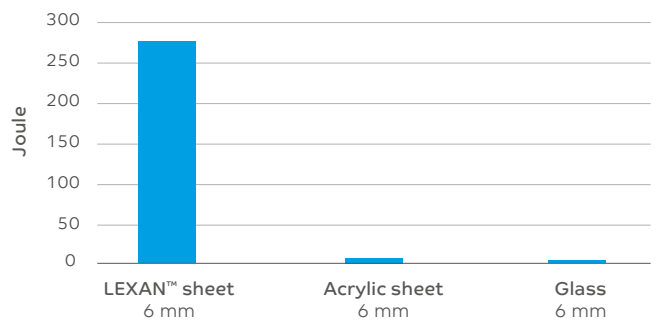

Image 2: Impact Resistance

Please, scan or click the QR code to watch the impact and fire performance video.



Impact Performance



Fire Performance

POTENTIAL BENEFITS



EXCELLENT CLEANING PERFORMANCE

Withstands repeated cleaning with common hospital cleaning agents. Gently wash the sheet with a solution of mild soap and lukewarm water, using a soft, grid-free cloth or sponge to loosen any dirt or grime.



HIGH CHEMICAL RESISTANCE

LEXAN™ solid sheet products have a high resistance to most moderate chemicals. For a complete list of compatible cleaners, please contact your SABIC representative.



ANTI-GRAFFITI

LEXAN™ MARGARD™ Sheet



THERMOFORMABLE



2 SIDES ABRASION RESISTANT



10-15 YEARS LIMITED “NO BREAK” WARRANTY



EASE OF INSTALLATION AND HANDLING



LIGHTWEIGHT (see table 3)

Material	Thickness (mm)	Surface Density (Kg/m ²)	Noise Reduction (dB)
Polycarbonate	8-12	9,6 - 14,4	30 – 33
Light Concrete	100	161	36
Dense Concrete	100	244	40
Brick	150	288	40
Panels Polyester film backed by Metal sheet	50 – 125	20 – 30	30 – 47

Table 3: Material comparison – Weight & Noise reduction

Please, scan or click the QR code to access all technical aspects of our product offering.



LEXAN™ EXELL™ D Sheet



LEXAN™ EXTRITE™ Sheet



LEXAN™ MARGARD™ Sheet

PRODUCT COMPARISON

LEXAN™ MARGARD™ sheet provides enhanced resistance to oils, paints and other fluids, making it ideal for use in close proximity with motor vehicles, or in areas prone to graffiti attack (the advantage of MARGARD sheet against EXTRITE™ and EXELL™ D sheet).

Unique surface coating of MARGARD and EXTRITE sheet provides high resistance to abrasion, to minimize damage by frequent contact or cleaning.

Features	EXELL™ D Sheet	EXTRITE™ Sheet	MARGARD™ Sheet
Excellent Sound Insulation	•	•	•
Impact Resistance	•	•	•
Long-term UV Protected	•	•	•
Fire Resistance	•	•	•
Transparency	•	•	•
Abrasion Resistance	-	•	•
Anti-Graffiti	-	-	•
Chemical Resistance	•	•	•
Thermoformability	•	-	With limitation in comparison to EXELL D

Table 4: Comparison between different degrees of LEXAN™ polycarbonate sheet

PRODUCT AVAILABILITY

Grade	Standard Size ¹ (mm)	Thickness (mm)	Colours ¹
LEXAN EXELL-D Sheet	2050 width	8, 9.5, 12, 15	112 (clear)
			5109 (bronze)
			713 (grey)
			GN8A081T Solar Control IR green
LEXAN EXTRITE Sheet	2050 width	8, 9.5, 12, 15	112 (clear)
			5109 (bronze)
			WH4D348O (opal white)
			GY6E575T (grey)
LEXAN MARGARD Sheet	2000 width	8, 9.5, 12, 15	112 (clear)
			5109 (bronze)
			713 (grey)
			GN8A081T Solar Control IR green

¹ Other colors, thicknesses & sizes available upon request.

Table 5: Product availability

PROJECT REFERENCES







ATTACHING A SHEET VIA WIRE TO PROFILES

INSTALLATION TIP FOR LOCATIONS WHERE THERE IS RISK OF FALLING DEBRIS LIKE BRIDGES

Materials intended for sound walls must adhere to safety standards due to their location on bridges, where the risk of falling debris can pose significant hazards. As such, fragile materials known to shatter into sharp fragments upon impact, like glass or polymethyl methacrylate (PMMA), are not recommended for these applications due to the potential danger they present.

LEXAN™ sheet, known for its high impact resistance, is a preferred choice, which is recently achieved 4C class certificate - highest in EN1794-2:20 test method classification. The probability of LEXAN™ polycarbonate sheets breaking is notably low. Nonetheless, it's important to note that when these sheets are affixed to a frame, they could

potentially dislodge completely under certain conditions. In these instances, securely fastening the polycarbonate sheet to the frame at certain points with a steel wire provides an adequate safety measure.

The method of fixing the sheets should be carefully considered to ensure it does not restrict the natural expansion and contraction - often referred to as thermal movement - of the material. Therefore, the attachment method should be intricately designed to accommodate this necessary thermal movement without compromising the safety or structural integrity of the installation.



PROPOSED CONCEPTS & INSTALLATION

FREEDOM OF DESIGN WITH LEXAN™ POLYCARBONATE SHEET

LEXAN™ sheet is light, easy to handle, and bendable. The sheet can be bent along its top edge. This eliminates the need for top profiles, making installation simpler. Sheet deflection, sound reflection and field of vision are also enhanced in this way.

Curve

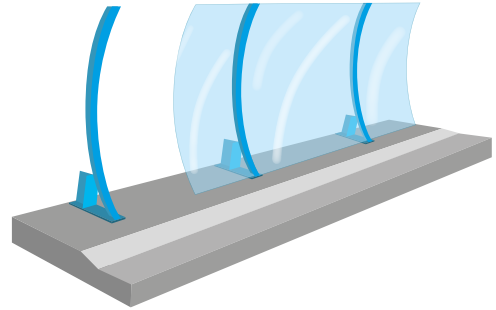

Hook

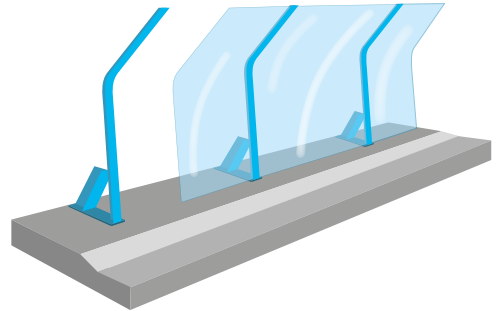

Wave

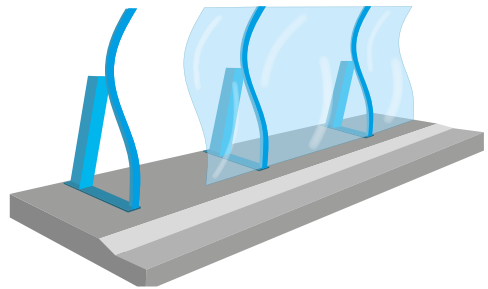

DESIGN CONCEPTS

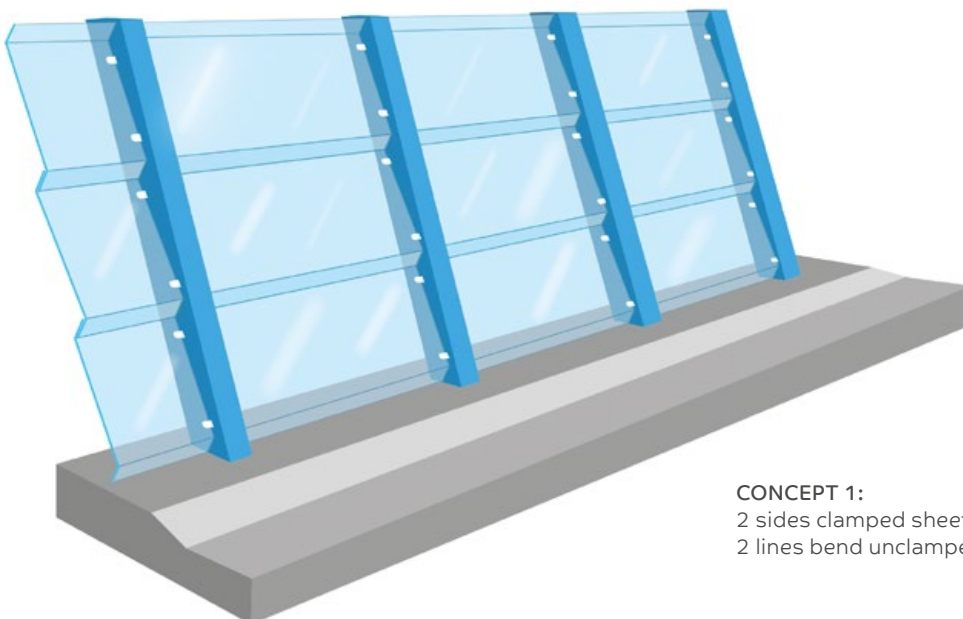

CONCEPT 1:
2 sides clamped sheet
2 lines bend unclamped sheet side

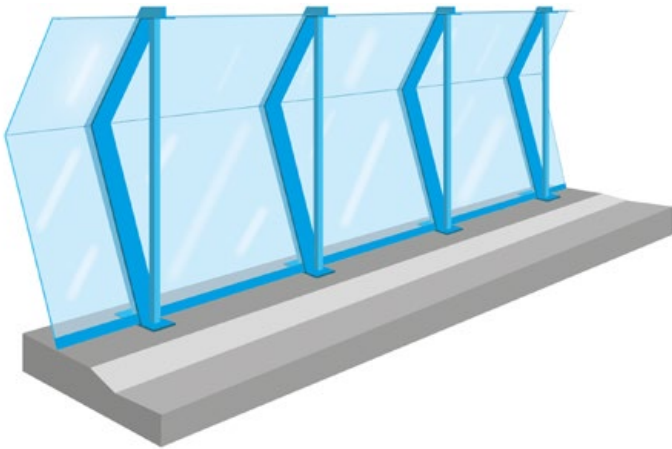

CONCEPT 2:
3 sides clamped sheet
1 line bend unclamped sheet side

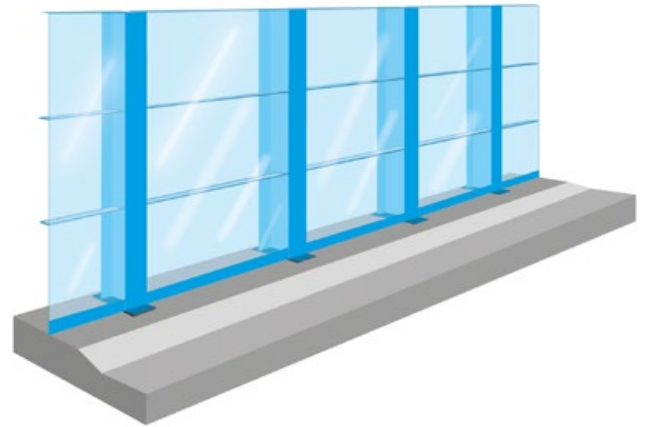

CONCEPT 3:
Line bend "U" shaped LEXAN™ Sheet panels
Pilled panels with bolted panel flanges

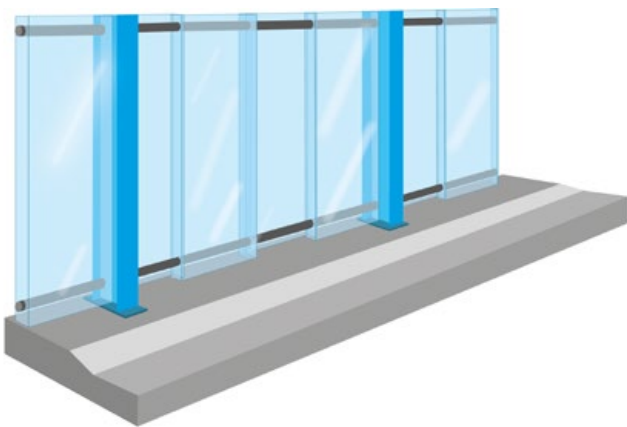

CONCEPT 4:
Vertical stacked line bended "U" shaped
LEXAN™ Sheet panels

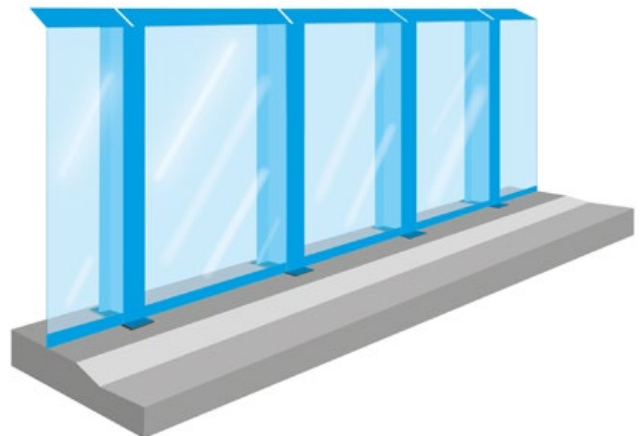

CONCEPT 5:
4 Sides clamped LEXAN Sheet panels

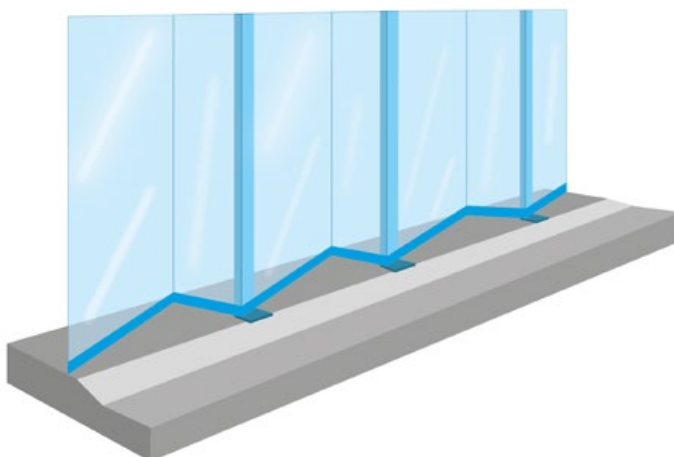

CONCEPT 6:
3 Sides clamped sheet vertical line bending

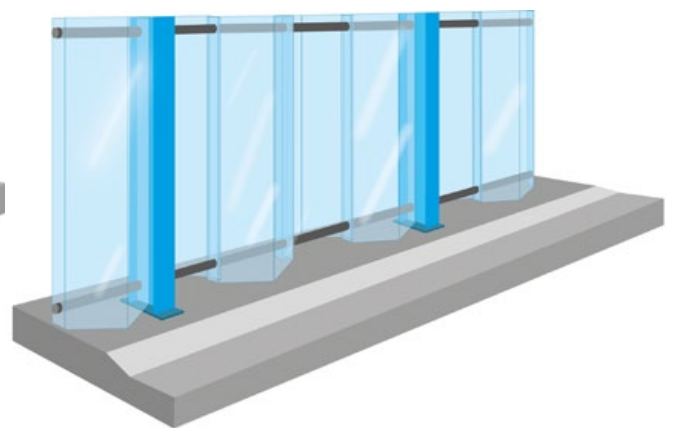

CONCEPT 7:
Vertical stacked line bended "U" shaped
LEXAN Sheet panels

INSTALLATION GUIDELINES

LEXAN™ sheet fixing proposals to vertical support profile

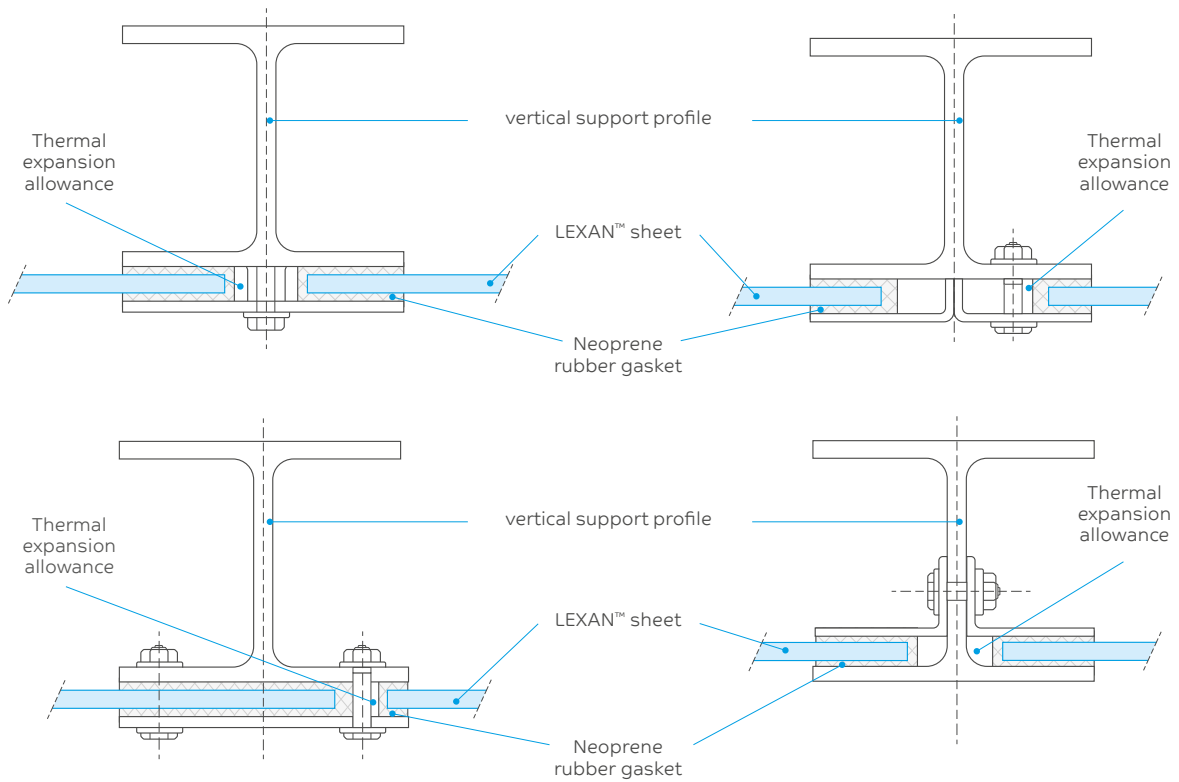

LEXAN™ sheet fixing proposals to top, middle, and bottom profile

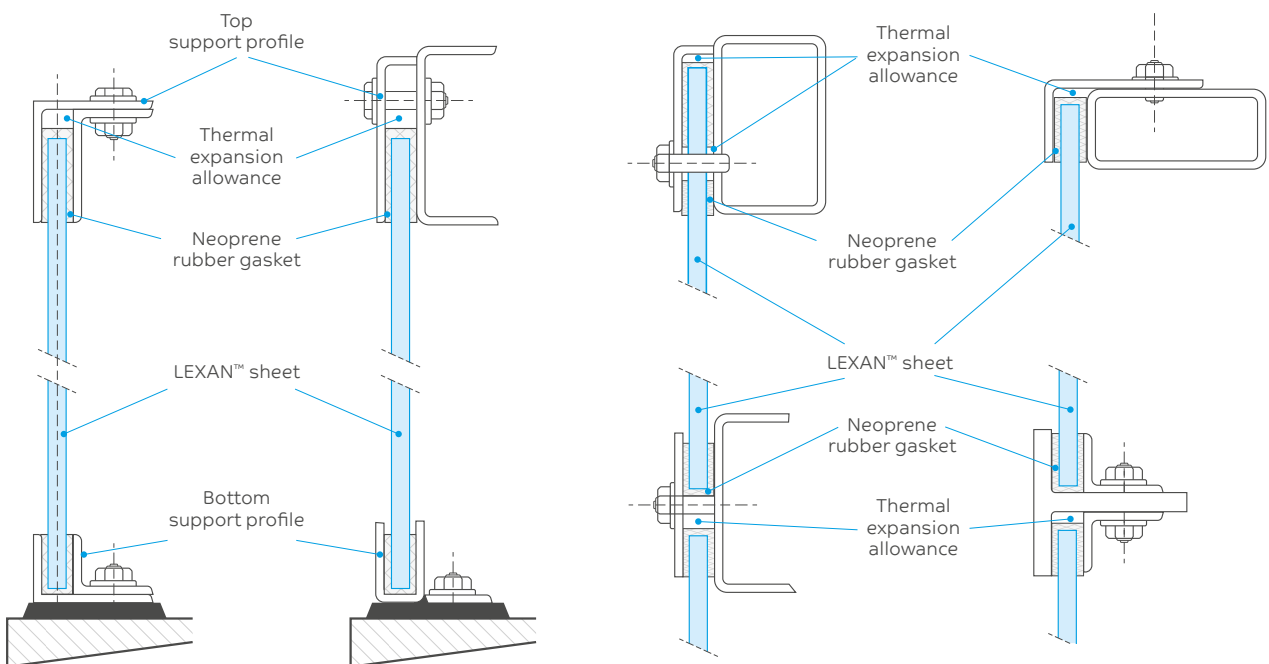

GLOBAL COMPANY WITH LOCAL SERVICES & SUPPLY

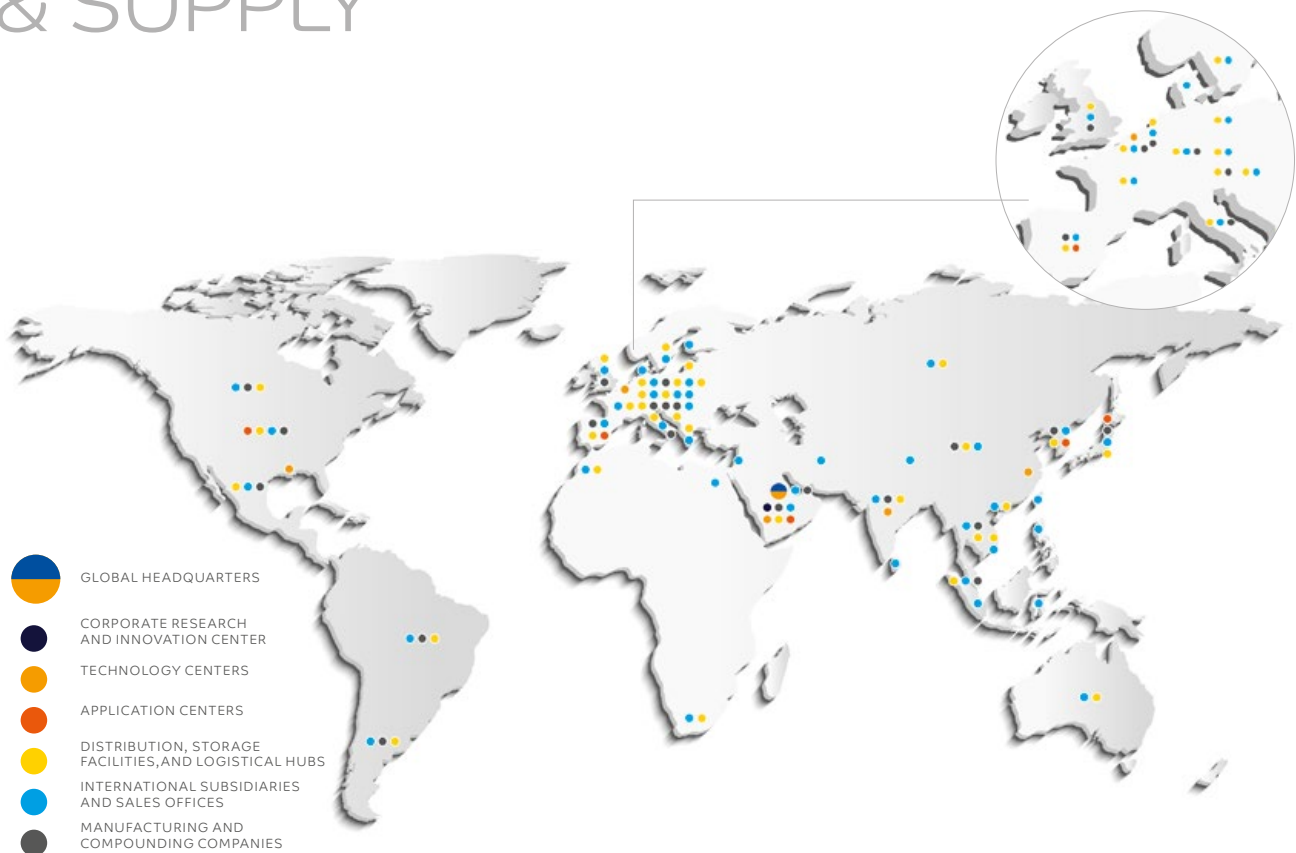

SABIC IS COMMITTED TO ITS CUSTOMERS AROUND THE WORLD WITH A PORTFOLIO OF SPECIALTY FILM & SHEET MATERIALS, APPLICATION SUPPORT AND WORLDWIDE SERVICES.

SABIC operates a worldwide network of sales, distribution, research, manufacturing and technical service facilities. SABIC serves customers around the world in a broad spectrum of industries and applications. SABIC offers global cross-business resources and expertise, and from its network of technical centers the company provides a variety of services. These include hands-on engineering and technical support that extends from selecting the right material to characteriza-

tion of mechanical, thermal, UV/heat aging data, advanced light measurements and optical modeling to part design and installation guidelines. The company also offers a local team, complete supply chain, and distribution organization to ensure a reliable source of materials to its customers wherever their manufacturing site is located.

SABIC ranks among the world's top petrochemical companies, and is a global market leader in

the production of polyethylene, polypropylene, advanced thermoplastics, glycols, methanol and fertilizers. SABIC operates in more than 45 countries across the world with 40,000 employees worldwide. It has significant research resources with 18 dedicated technology and innovation facilities in Saudi Arabia, the USA, the Netherlands, Spain, India and China.

CONTACT US

SABIC Global Headquarters

PO Box 5101
Riyadh 11422
Saudi Arabia
T +966 (0) 1 225 8000
E info@sabic.com

Americas

SABIC
Functional Forms
2500 CityWest Boulevard
Suite 100
Houston, Texas 77042
USA
T +1 800 323 3783
E spinside.sales@sabic.com

Europe

SABIC
Functional Forms
Jouleshof 16
4622 RG Bergen op Zoom
The Netherlands
T +31 (0)164 293684
E ff.info@sabic.com

Pacific

SABIC
Functional Forms
2550 Xiupu Road
Pudong
201319 Shanghai
China
T +86 20 2866 6168
E ff.info@sabic.com



DISCLAIMER: THE MATERIALS, PRODUCTS AND SERVICES OF SAUDI BASIC INDUSTRIES CORPORATION (SABIC) OR ITS SUBSIDIARIES OR AFFILIATES ("SELLER") ARE SOLD SUBJECT TO SELLER'S STANDARD CONDITIONS OF SALE, WHICH ARE AVAILABLE UPON REQUEST. INFORMATION AND RECOMMENDATIONS CONTAINED IN THIS DOCUMENT ARE GIVEN IN GOOD FAITH. HOWEVER, SELLER MAKES NO EXPRESS OR IMPLIED REPRESENTATION, WARRANTY OR GUARANTEE (i) THAT ANY RESULTS DESCRIBED IN THIS DOCUMENT WILL BE OBTAINED UNDER END-USE CONDITIONS, OR (ii) AS TO THE EFFECTIVENESS OR SAFETY OF ANY DESIGN OR APPLICATION INCORPORATING SELLER'S MATERIALS, PRODUCTS, SERVICES OR RECOMMENDATIONS. UNLESS OTHERWISE PROVIDED IN SELLER'S STANDARD CONDITIONS OF SALE, SELLER SHALL NOT BE RESPONSIBLE FOR ANY LOSS RESULTING FROM ANY USE OF ITS MATERIALS, PRODUCTS, SERVICES OR RECOMMENDATIONS DESCRIBED IN THIS DOCUMENT. Each user is responsible for making its own determination as to the suitability of Seller's materials, products, services or recommendations for the user's particular use through appropriate end-use and other testing and analysis. Nothing in any document or oral statement shall be deemed to alter or waive any provision of Seller's Standard Conditions of Sale or this Disclaimer, unless it is specifically agreed to in a writing signed by Seller. Statements by Seller concerning a possible use of any material, product, service or design do not, are not intended to, and should not be construed to grant any license under any patent or other intellectual property right of Seller or as a recommendation for the use of any material, product, service or design in a manner that infringes any patent or other intellectual property right.

SABIC and brands marked with TM are trademarks of SABIC or its subsidiaries or affiliates.
© 2024 SABIC. All Rights Reserved.